

Get started

Download the LIFX app to begin.



## Safety Instructions + Installation Guide

LIFX Ceiling

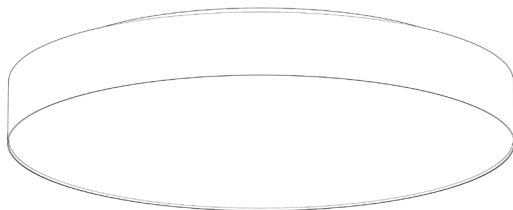

Surface Mount  
38 cm luminaire



Prefer setup videos?  
Text here too small or long?  
Visit [lifx.com/getstarted](https://lifx.com/getstarted)



Connects to  
your 2.4 GHz  
Wi-Fi network.

! SUPER QUICK SETUP

**This is your matter code.**  
You'll need this after installing  
your light and turning it on.



### Need extra help?

We've got tips & articles  
at [support.lifx.com](https://support.lifx.com) or you  
can chat with us live at  
[LIFX.com](https://lifx.com)

**IMPORTANT!**  
Keep this code.

# Installing your Ceiling Light.

**WARNING: RISK OF SHOCK.**  
House electric current can cause painful shock or serious injury unless handled properly.



## ! Cautions:

- Turn off the main power at the circuit breaker before installing the fixture in order to prevent possible shock.
- Ground the fixture to avoid potential electric shocks and to ensure reliable starting.
- Double-check all connections to be sure they are tight and correct.
- Wear rubber soled shoes and work on a sturdy wooden ladder.
- Consult a qualified electrician to ensure a correct branch circuit conductor.
- This product is designed for use in a circuit protected by a fuse or circuit breaker.

**WARNING: RISK OF FIRE OR ELECTRIC SHOCK.**  
Use only on 120-240 volt 50/60Hz circuits.  
Suitable for damp locations. Before installing your lighting fixture, thoroughly review this installation manual.

Installation requires knowledge of luminaire electrical systems. If not qualified, do not attempt installation, contact a qualified electrician. Installing by the hardwire method outlined is illegal without an appropriate electrical licence. Reliable operating temperature is -20 °C to 40 °C.

Do not install or use the product without the included metal bracket. There must be no access to the rear side of the light after installation

**WARNING: RISK OF CUTS.** Some metal parts in the fixture may have sharp edges. To prevent cuts and scrapes, wear gloves when handling the parts.

Ensure you account for small parts and destroy packing material, as these may be hazardous to children.

## Let's begin.

To install you'll need:

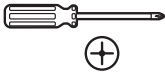

Phillips Screwdriver

### 1 TURN OFF POWER

Ensure the power is off at the switch *and* the fusebox or circuit breaker.

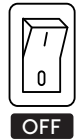

### 2 PREPARE TO MOUNT TO CEILING

#### Remove the mounting plate.

Carefully unpack your new LIFX Ceiling fixture (A) and remove the mounting plate (B) from the back of the fixture by twisting (B) to unlock and lifting off.

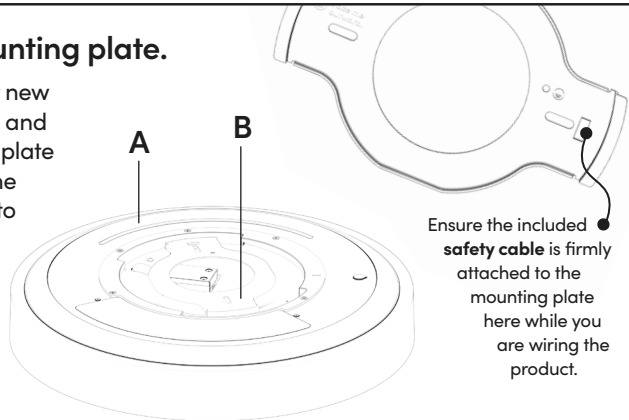

### Decide where your Ceiling Light will go.

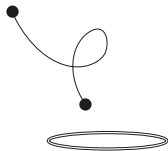

You'll need to decide how to install. If you are planning to plug in your light, you may be able to use an existing downlight hole and electrical outlet or a powerpoint, which could influence location.

### Mark the bolt positions.

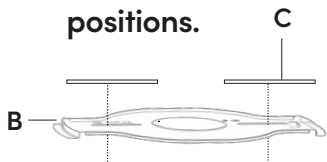

Align the mounting plate (B) to the surface (C) and make a mark in the two outer holes.

### Drill the holes.

Remove the plate and drill 13mm holes to fit the toggle bolts (D)

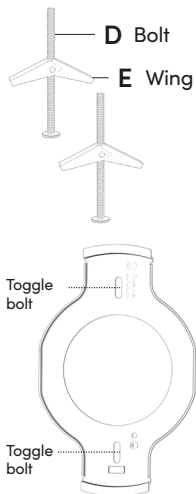

### Affix plate to ceiling securely.

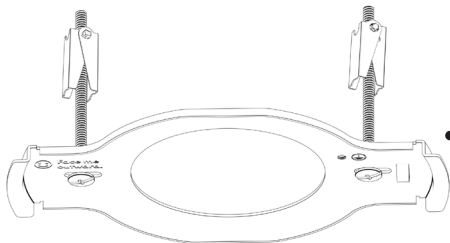

Fold down the wings and insert into the drilled holes - this will be a snug fit for a more secure installation. The wings will expand. Pull toggle bolts downwards to engage.

Check you can access the home lighting wires or plug outlet to connect the light. Tighten the toggle bolts to secure the mounting bracket firmly in place, ensuring it remains stable without any movement.

### Remove wings (E) and fit bolts (D) to plate (B), adding wings to the back.

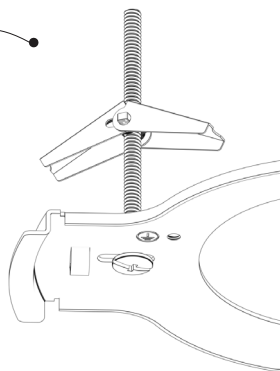

### Connect Safety Cable.

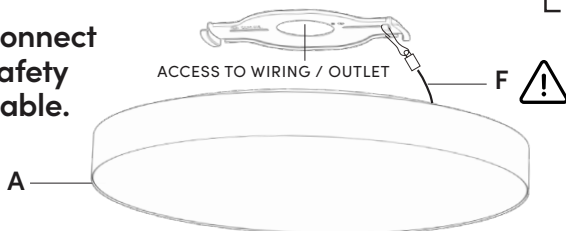

Lift the fixture (A) towards the secured mounting plate and attach safety cable (F).

4

## CONNECT OR WIRE

### Simply Plug in...

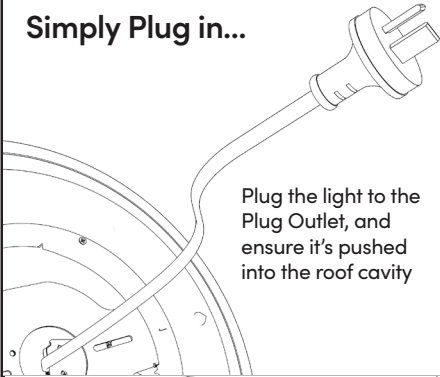

Plug the light to the Plug Outlet, and ensure it's pushed into the roof cavity

**WARNING: RISK OF SHOCK.**  
If not qualified, do not attempt wired installation. Contact a qualified electrician.



### Or hardwire.

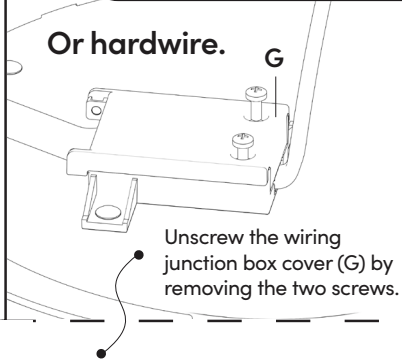

Unscrew the wiring junction box cover (G) by removing the two screws.

Disconnect the attached plug (H).

Now connect the Live wire (Brown), Neutral (Blue) and Ground wires (Green).

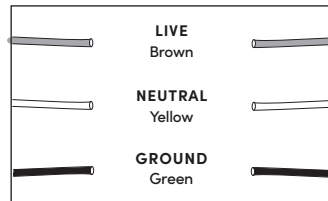
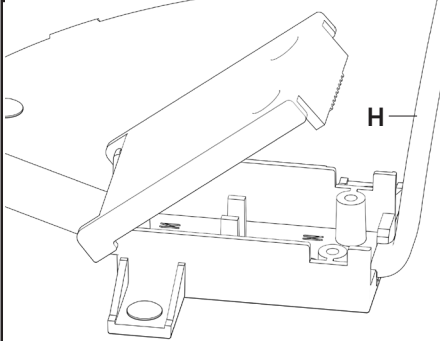

### Once they're connected...

Ensure all screws are tight, and all wires are secure.

Close the junction box, and fix closed using the screws removed when opening.

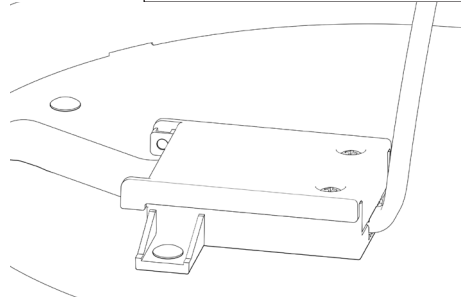

5

## TWIST ON TO MOUNT

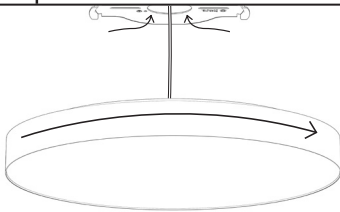

### Attach the Fixture.

Tuck the electrical wires and safety cable into the ceiling cavity, then lift the fixture against the mounting plate. Turn the fixture clock-wise to lock the fixture to the mounting plate.

# Adding your light to your app.

- 1 Download the LIFX App and sign in.
- 2 Make sure your light is on.
- 3 Hit the + button in the bottom right.

We'll guide you through from there.

You'll use the code on the front of this manual for quick setup in the LIFX app too.

## USING MATTER?

Just scan the code on the front of this manual and pick the smart home platform you want to add your light to.

To use Matter home and away, you'll need a Google, Apple or other smart home hub that's Matter-enabled. Devices with older hardware may not be compatible.

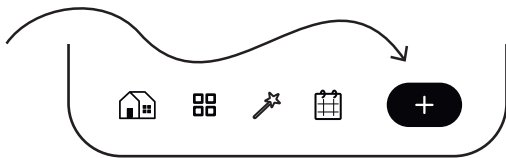

Use the '+' to add new products, schedule lighting changes or to snapshot your current lighting and save as a Scene so you can trigger it again easily later.

## Product Details

120-240V AC  
50/60Hz

© 2025  
**All rights reserved.**  
Covered by patents.  
[lifx.com/patents](http://lifx.com/patents)

### Chromaticity co-ordinates: colored light

$x < 0,270$  or  $x > 0,530$

$y < -2,3172 x^2 + 2,3653 x - 0,2199$

or  $y > -2,3172 x^2 + 2,3653 x - 0,1595$

FEIT ELECTRIC CO. is the exclusive owner of rights and interests in and to the mark LIFX and the LIFX logo.

LIFX works diligently to ensure that LIFX products and their packaging materials comply with all relevant regulations in the regions we supply. See [lifx.com/compliance](http://lifx.com/compliance) for notices for your region.



Minimum starting temperature.



Reaches 100% brightness in 1 second or less.



High quality LEDs rated for 25,000 hours of use.



Connects to your routers 2.4GHz Wi-Fi band.



Not suitable for use under dust and moisture.

## Australian Consumer Law

Our goods come with guarantees that cannot be excluded under the Australian Consumer Law. You are entitled to a replacement or refund for a major failure and compensation for any other reasonably foreseeable loss or damage. You are also entitled to have the goods repaired or replaced if the goods fail to be of acceptable quality and the failure does not amount to a major failure.

## RoHS

Router | 802.11 b/g/n | WPA2 security compatible

### Technical Requirements:

- A device running **iOS 14.0+** or **Android 8.0+**

- **Wi-Fi internet connection.**

Wi-Fi access point must be 802.11b, g or n compliant with WPA2 security and a DHCP-configured connection available for every connected LIFX light.

### How do I reset a light to factory settings ?

Turn the light off and on at the switch 5 times, about one switch every two seconds (not too fast). The lights will cycle through four colors when the reset has been successful.

This product is distributed by:

## Clever House Pty Ltd

For consumer inquiries please email [info@cleverhouse.cc](mailto:info@cleverhouse.cc)

# Regulations & Compliance.

## Limited Warranty

### General

Feit Electric Co ("LIFX") warrants the LIFX bulb (the "Product"), and only the Product, against defects in materials and workmanship under normal use ("Defect") for a period of TWO YEARS (730 days) from the date of retail purchase by the original purchaser ("Warranty Period"). Under this Limited Warranty, if a defect arises and a valid claim is received by LIFX® within the Warranty Period, at its option and to the extent permitted by law, LIFX will either: 1. repair the Product at no charge, using new or refurbished replacement parts --or-- 2. exchange the Product with a new or refurbished Product.

In the event of a defect, to the extent permitted by law, these are your sole and exclusive remedies. A replacement Product or part assumes the remaining warranty of the original Product or ninety (90) days from the date of replacement or repair, whichever is longer. When a Product or part of the Product is exchanged, any replacement item becomes your property and the replaced item becomes LIFX's property. Parts provided by LIFX in fulfillment of its warranty obligation must be used in Products for which warranty service is claimed.

### Exclusions & Limitations

This Limited Warranty applies only to the Product manufactured by or for LIFX that can be identified by the "LIFX trademark, trade name, or logo affixed to it. The Limited Warranty does not apply to any (a) LIFX products and services other than the Product, (b) non- LIFX hardware product, (c) consumables (such as batteries), or (d) software, even if packaged or sold with the Product or embedded in the Product. Refer to the licenses accompanying the software for details of your rights with respect to its use. LIFX does not warrant that the operation of the Product will meet your needs or requirements or be uninterrupted or error free. LIFX is not responsible for damage arising from failure to follow instructions relating to the Product's use or from failures resulting from inadequate electrical supply or internet access. This warranty does not apply to a Product or part of the Product that has been altered or modified (e.g. to alter functionality or capability) by anyone who is not a representative of LIFX or if the Product is inserted or installed in a casing not provided by LIFX. In addition, this Limited Warranty does not apply to Defects or damage caused by (a) use with non-LIFX products; (b) accident, abuse, misuse, flood, fire, earthquake or other external causes or abnormal conditions; (c) operating the product outside the permitted or intended uses or conditions described by LIFX or with improper voltage or power supply; or (d) service (including upgrades and expansions) performed by anyone who is not a representative of LIFX. Recovery and reinstallation of software programs and user data are not covered under this Limited Warranty. This Limited Warranty does not cover the cost of returning the Product to LIFX; this is your responsibility. No LIFX reseller, agent, or employee is authorized to

make any modification, extension, or addition to this Limited Warranty. If any term is held to be illegal or unenforceable, the legality or enforceability of the remaining terms shall not be affected or impaired.

### EXCLUSIVE WARRANTIES

THE WARRANTIES SET FORTH HEREIN ARE THE EXCLUSIVE WARRANTIES PROVIDED BY LIFX, AND EXCEPT TO THE EXTENT PROHIBITED BY APPLICABLE LAW, ALL OTHER WARRANTIES, WHETHER EXPRESS OR IMPLIED WARRANTIES (INCLUDING WARRANTIES OF MERCHANTABILITY, FITNESS FOR A PARTICULAR PURPOSE AND NON INFRINGEMENT) ARE HEREBY EXCLUDED.

### LIMITATION OF DAMAGES

EXCEPT TO THE EXTENT PROHIBITED BY APPLICABLE LAW, LIFX SHALL NOT BE LIABLE FOR ANY INCIDENTAL, INDIRECT, SPECIAL, OR CONSEQUENTIAL DAMAGES RESULTING FROM ANY USE OF THE PRODUCT OR BREACH OF EXPRESS OR IMPLIED WARRANTY OR CONDITION, OR UNDER ANY OTHER LEGAL THEORY. LIFX'S LIABILITY FOR DAMAGES RESULTING FROM ANY USE OF THE PRODUCT OR BREACH OF EXPRESS OR IMPLIED WARRANTY OR CONDITION, OR UNDER ANY OTHER LEGAL THEORY WILL BE LIMITED TO THE ORIGINAL COST PAID FOR OF THE DEFECTIVE PRODUCT.

### Consumer Protection

Some states do not allow the exclusion or limitation of incidental or consequential damages, or allow limitations on how long an implied warranty lasts, so the above limitations or exclusions may not apply to you. This warranty gives you specific legal rights, and you may also have other rights that vary by state to state.

### Governing Law and Arbitration

This Limited Warranty shall be governed by the laws of the State of California without giving effect to any conflict of laws principles that may provide the application of the law of another jurisdiction and without regard to the Convention on Contracts for the International Sale of Goods. Any claim or dispute in connection with this Limited Warranty shall be resolved in a cost effective manner through binding non appearance based arbitration. The arbitration shall be initiated through an established alternative dispute resolution provider mutually agreed upon by the parties. The alternative dispute resolution provider and the parties must comply with the following rules: a) the arbitration shall be conducted by telephone, online and/or be solely based on written submissions, the specific manner shall be chosen by the party initiating the arbitration; b) the arbitration shall not involve any personal appearance by the parties or witnesses unless otherwise mutually agreed by the parties; and c) any judgement on the award rendered by the arbitrator may be entered in any court of competent jurisdiction. If the foregoing arbitration clause does not apply for any reason, you agree to submit to the personal jurisdiction of the state courts located within San Francisco County, California and the federal courts in the Northern District of California for the purpose of litigating all such claims or disputes, which courts shall have exclusive jurisdiction of such claims or disputes. Notwithstanding the foregoing, LIFX may seek injunctive or other equitable relief to protect its intellectual property rights in any court of competent jurisdiction.